

## SCHEDA TECNICA CONVERSA CAMINO

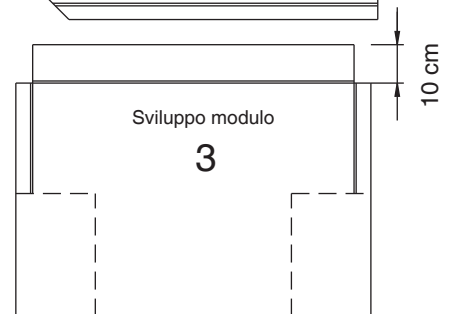
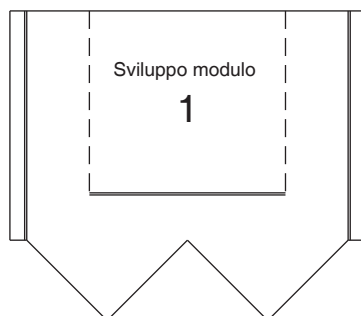
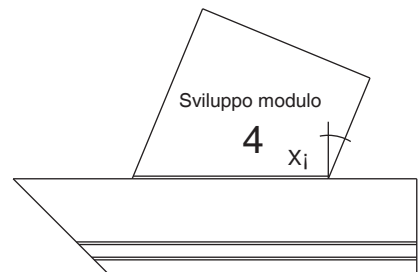
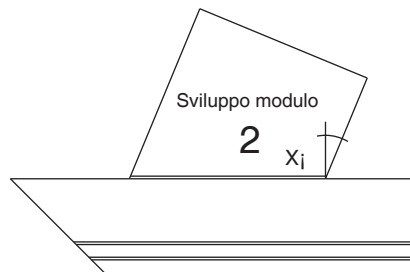
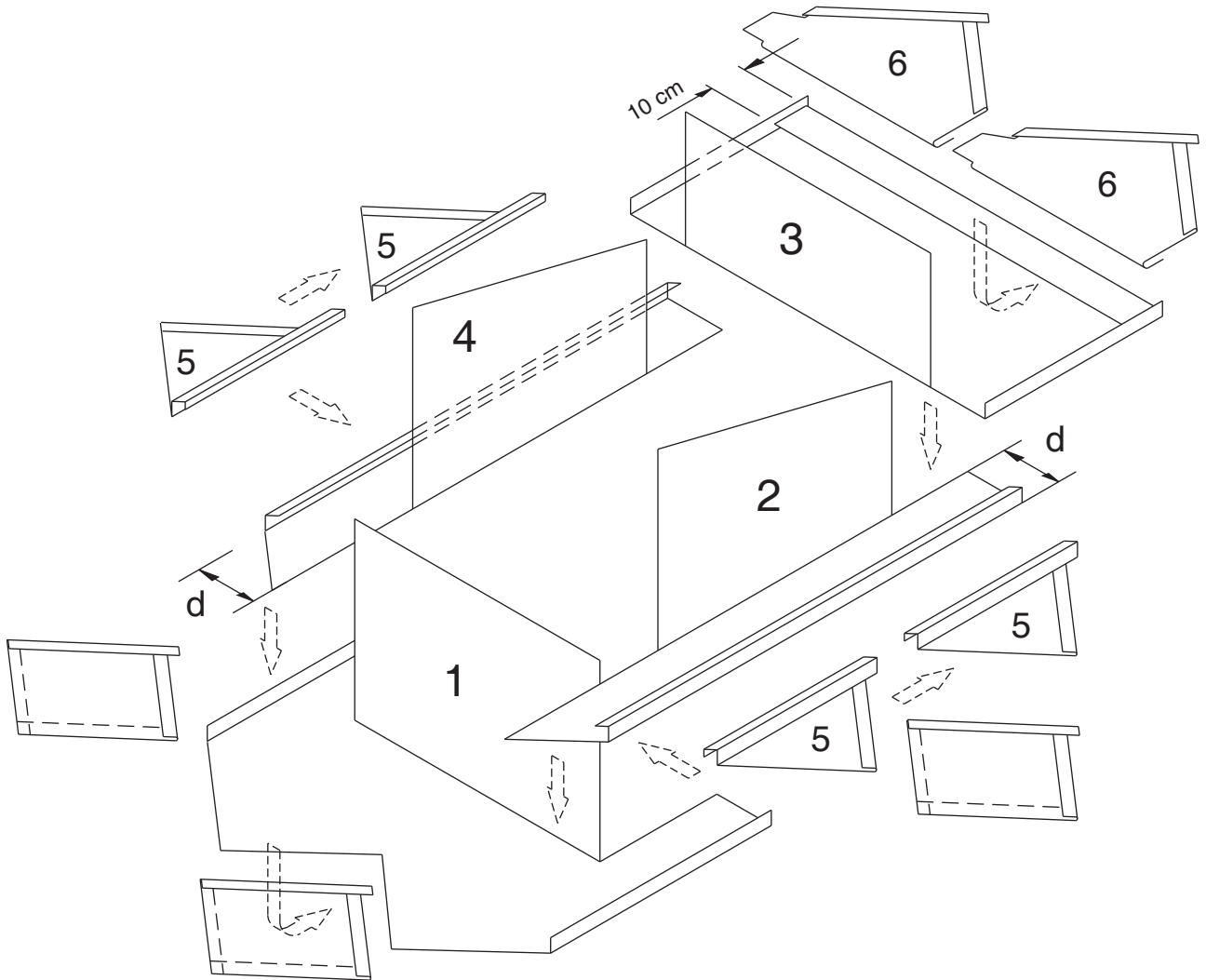

### LEGENDA

— Piega

- - - Taglio

$X_i$  = Angolo di inclinazione tetto

# SCHEDA TECNICA CONVERSA CAMINO

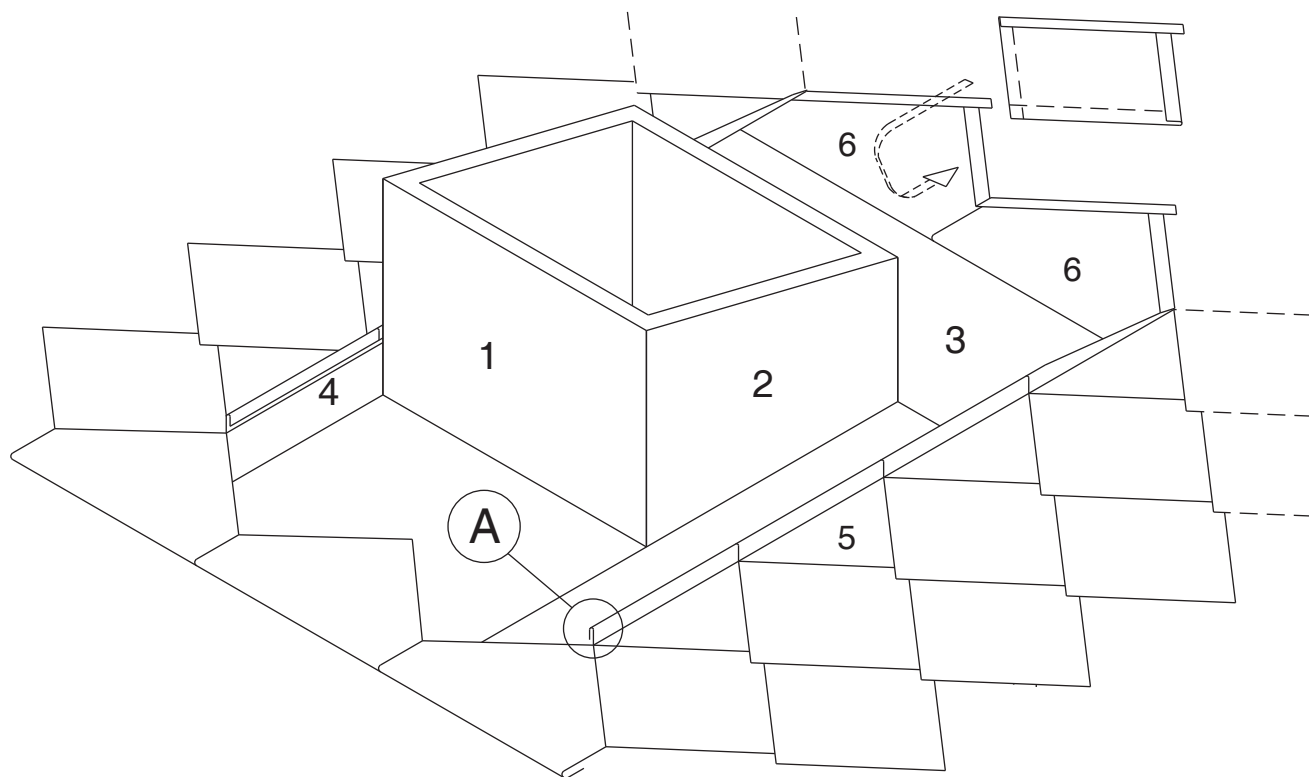

DETTAGLIO "A" aperto

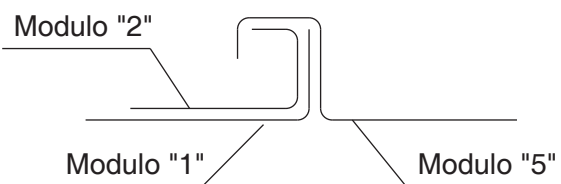

DETTAGLIO "A" chiuso

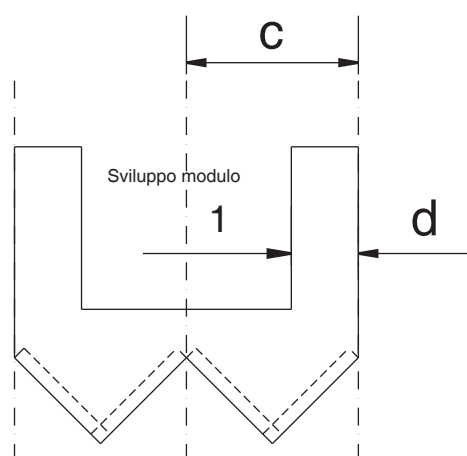
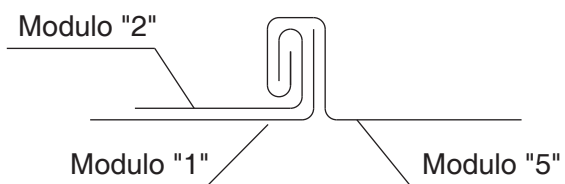

**C** = Interasse supporti per fissaggio della scandola (met<sup>2</sup> diagonale)